

FEATURES

- High breakdown voltage up to 650V for improved reliability
- Trench-Stop Technology offering :
 - High speed switching
 - High ruggedness, temperature stable
 - Short circuit withstand time – 5μs
 - Low V_{CEsat}
 - Easy parallel switching capability due to positive temperature coefficient in V_{CEsat}

V_{CE}	650	V
I_C	75	A
$V_{CE(SAT)} I_C=75A$	1.7	V

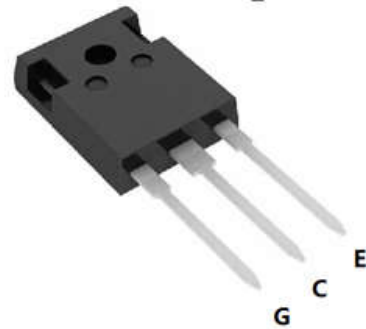
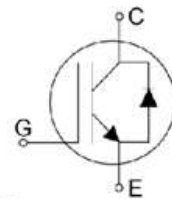

APPLICATION

- Uninterruptible Power Supplies
- Inverter
- Welding Converters
- PFC applications
- Converter with high switching frequency

Product	Package	Packaging
YGW75N65T1	TO247	Tube

Maximum Ratings ($T_j = 25^\circ\text{C}$ unless otherwise specified)

Parameter	Symbol	Value	Unit
Collector-Emitter Breakdown Voltage	V_{CE}	650	V
DC collector current, limited by T_{jmax} $T_C = 25^\circ\text{C}$ $T_C = 100^\circ\text{C}$	I_C	150 75	A
Diode Forward current, limited by T_{jmax} $T_C = 25^\circ\text{C}$ $T_C = 100^\circ\text{C}$	I_F	150 75	A
Continuous Gate-emitter voltage	V_{GE}	± 20	V
Transient Gate-emitter voltage	V_{GE}	± 30	V
Turn off safe operating area $V_{CE} \leq 650\text{V}$, $T_j \leq 150^\circ\text{C}$, $t_p = 1\mu\text{s}$	-	225	A
Pulse collector current, $V_{GE} = 15\text{V}$, t_p limited by T_{jmax}	I_{CM}	225	A
Short Circuit Withstand Time, $V_{GE} = 15\text{V}$, $V_{CE} \leq 400\text{V}$	T_{sc}	5	μs
Power dissipation, $T_j = 25^\circ\text{C}$	P_{tot}	416	W
Operating junction temperature	T_j	-40...+150	$^\circ\text{C}$
Storage temperature	T_s	-55...+150	$^\circ\text{C}$
Soldering temperature, wave soldering 1.6mm (0.063in.) from case for 10s	-	260	$^\circ\text{C}$

Thermal Resistance

Parameter	Symbol	Max. Value	Unit
IGBT thermal resistance, junction - case	$R_{\theta(j-c)}$	0.3	K/W
Diode thermal resistance, junction - case	$R_{\theta(j-c)}$	0.8	K/W
Thermal resistance, junction - ambient	$R_{\theta(j-a)}$	40	K/W

Electrical Characteristics ($T_j = 25^\circ\text{C}$ unless otherwise specified)

Parameter	Symbol	Conditions	Min	Typ	Max	Unit
Static						
Collector-Emitter Breakdown Voltage	BV_{CES}	$V_{GE}=0V, I_C=250\mu A$	650		-	V
		$V_{GE}=0V, I_C=1mA$	650			V
Gate Threshold Voltage	$V_{GE(th)}$	$V_{GE}=V_{CE}, I_C=250\mu A$	4.6	5.6	6.2	V
Collector-Emitter Saturation Voltage	$V_{CE(sat)}$	$V_{GE}=15V, I_C=75A$ $T_j = 25^\circ\text{C}$ $T_j = 150^\circ\text{C}$	-	1.7	2.2	V
			-	2.2		V
Zero gate voltage collector current	I_{CES}	$V_{CE} = 650V, V_{GE} = 0V$ $T_j = 25^\circ\text{C}$ $T_j = 150^\circ\text{C}$		0.1	40 5000	μA
Gate-emitter leakage current	I_{GES}	$V_{CE} = 0V, V_{GE} = \pm 20V$			100	nA
Transconductance	gfs	$V_{CE} = 20V, I_C = 75A$	-	40	-	S

Parameter	Symbol	Conditions	Min	Typ	Max	Unit
Dynamic						
Input capacitance	C_{ies}	$V_{CE} = 25V, V_{GE} = 0V,$ $f = 1MHz$		4500		pF
Output capacitance	C_{oes}			200		
Reverse transfer capacitance	C_{res}			100		
Gate charge	Q_G	$V_{CC} = 480V, I_C = 75A,$ $V_{GE} = 15V$	-	260	-	nC
Short circuit collector current	$I_{C(SC)}$	$V_{GE}=15V, t_{sc} \leq 5\mu s$ $V_{CC}=400V,$ $T_{j, start}=25^\circ\text{C}$	-	350	-	A

Switching Characteristic, Inductive Load

Parameter	Symbol	Conditions	Min	Typ	Max	Unit
Dynamic $T_j=25^\circ\text{C}$						
Turn-on Delay Time	$t_{d(\text{on})}$	$V_{CC} = 400\text{V}, I_C = 75.0\text{A},$ $V_{GE} = 0.0/15.0\text{V},$ $R_g = 30\Omega$	-	110	-	ns
Rise Time	t_r		-	40	-	ns
Turn-off Delay Time	$t_{d(\text{off})}$		-	660	-	ns
Fall Time	t_f		-	60	-	ns
Turn-on Energy	E_{on}		-	4.3	-	mJ
Turn-off Energy	E_{off}		-	8.4	-	mJ

Electrical Characteristics of the DIODE ($T_j = 25^\circ\text{C}$ unless otherwise specified)

Parameter	Symbol	Conditions	Min	Typ	Max	Unit
Dynamic						
Diode Forward Voltage	V_{FM}	$I_F = 75\text{A}$	-	1.9	-	v
Reverse Recovery Time	T_{rr}	$I_F = 75\text{A},$ $V_R = 400\text{V},$ $di/dt = 600\text{A}/\mu\text{s},$	-	50	-	ns
Reverse Recovery Current	I_{rr}		-	12	-	A
Reverse Recovery Charge	Q_{rr}		-	350	-	nC

Fig. 1 FBSOA characteristics

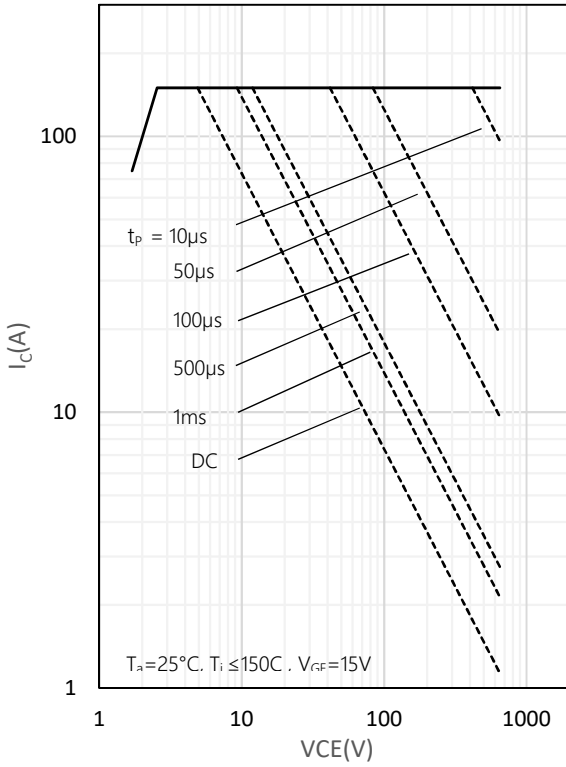

Fig. 2 Power dissipation as a function of T_C

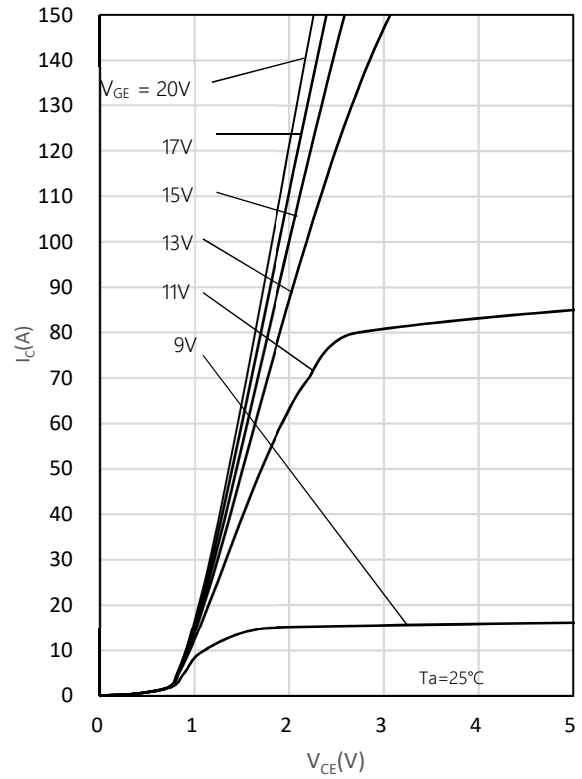

Fig. 3 collector current as a function of T_C

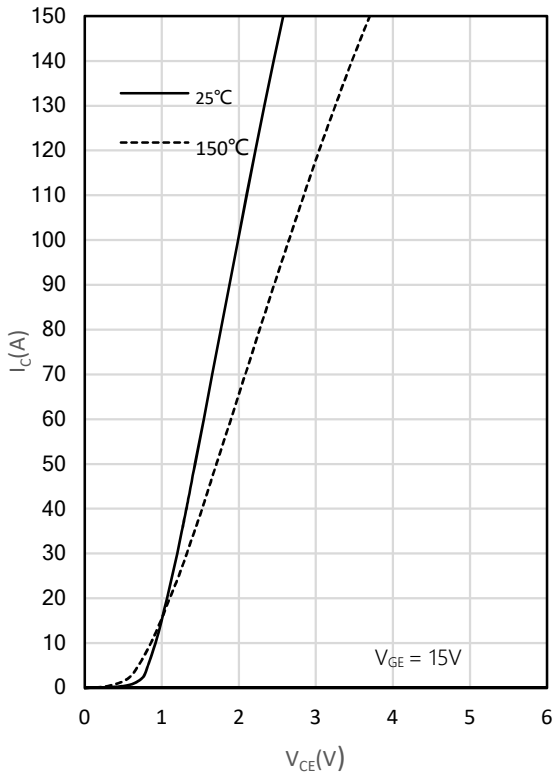

Fig. 4 Switching times vs. gate resistor

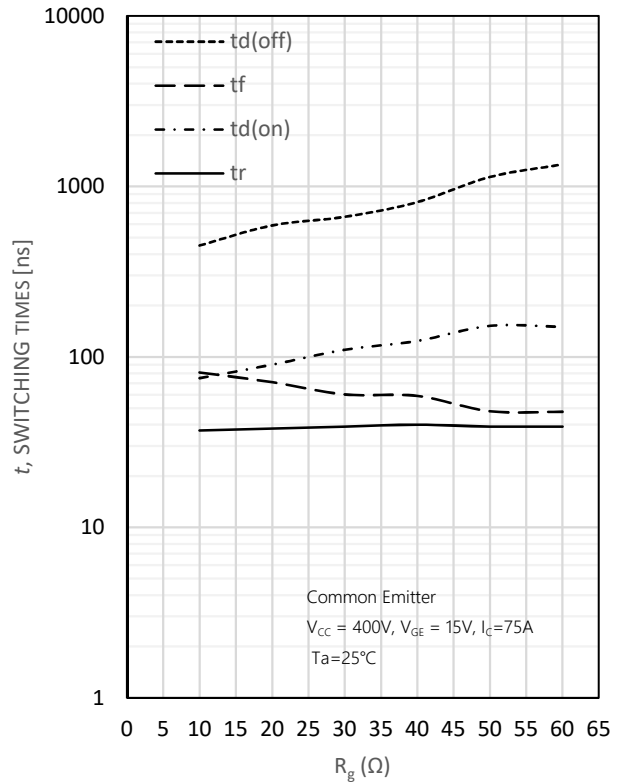

Fig. 5 Switching loss vs. gate resistor

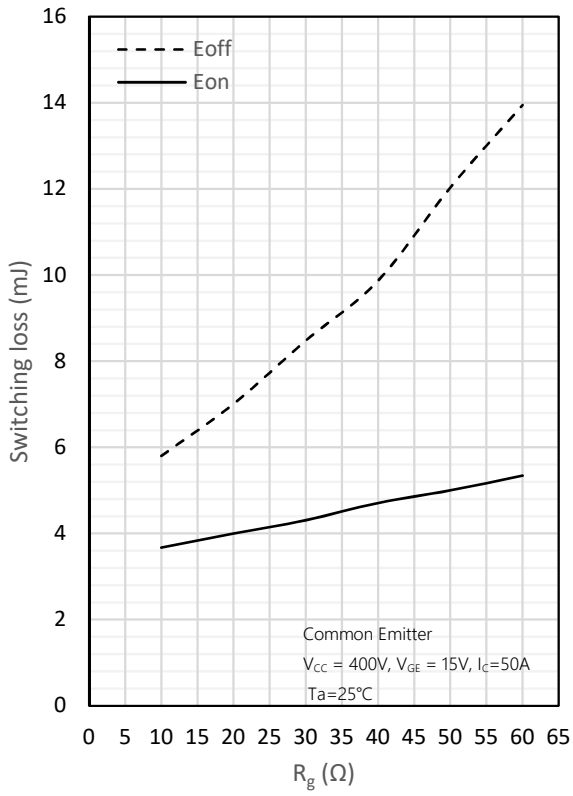

Fig. 6 Gate charge characteristics

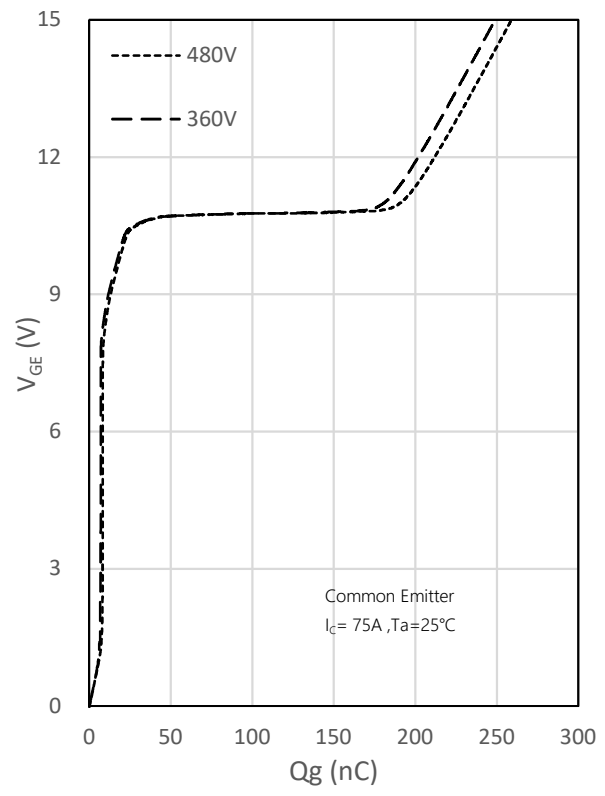
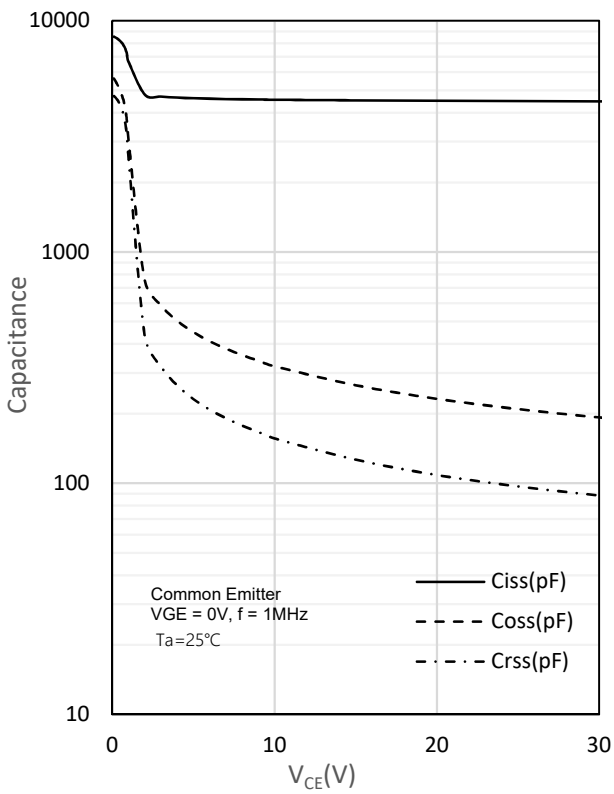
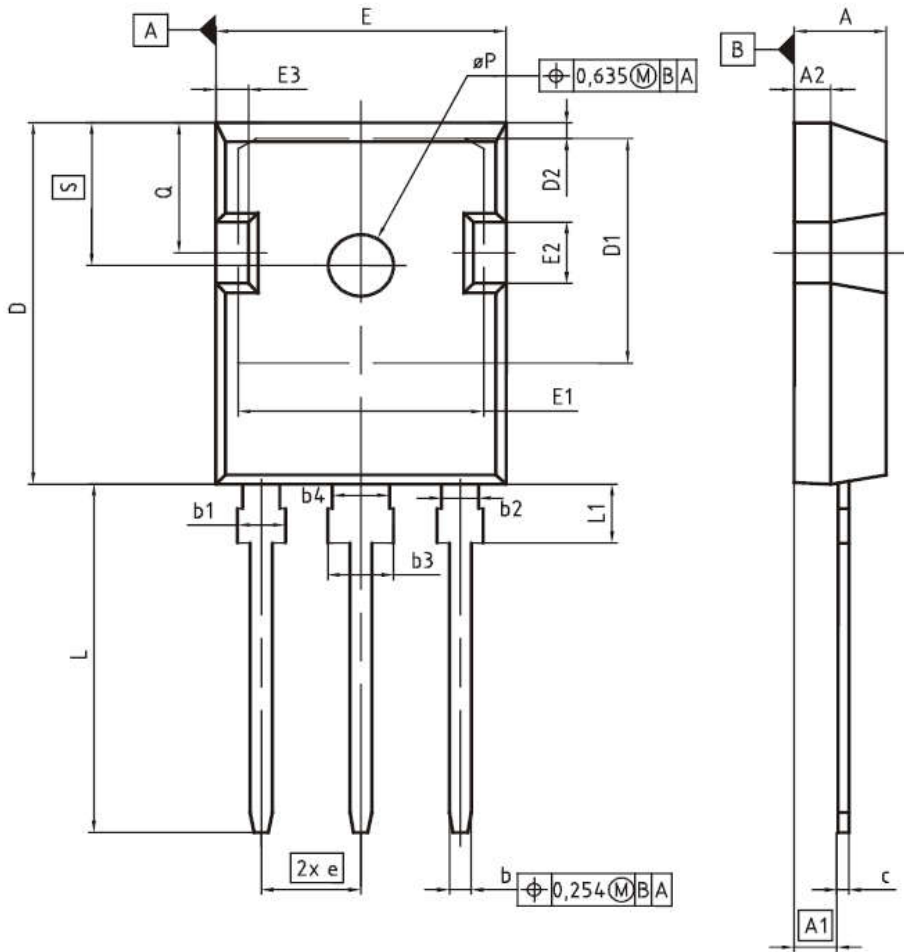

Fig. 7 Capacitance characteristics



PG-TO247-3



DIM	MILLIMETERS		INCHES	
	MIN	MAX	MIN	MAX
A	4.83	5.21	0.190	0.205
A1	2.27	2.54	0.089	0.100
A2	1.85	2.16	0.073	0.085
b	1.07	1.33	0.042	0.052
b1	1.90	2.41	0.075	0.095
b2	1.90	2.16	0.075	0.085
b3	2.87	3.38	0.113	0.133
b4	2.87	3.13	0.113	0.123
c	0.55	0.68	0.022	0.027
D	20.80	21.10	0.819	0.831
D1	16.25	17.65	0.640	0.695
D2	0.95	1.35	0.037	0.053
E	15.70	16.13	0.618	0.635
E1	13.10	14.15	0.516	0.557
E2	3.68	5.10	0.145	0.201
E3	1.00	2.60	0.039	0.102
e	5.44 (BSC)		0.214 (BSC)	
N	3		3	
L	19.80	20.32	0.780	0.800
L1	4.10	4.47	0.161	0.176
ϕP	3.50	3.70	0.138	0.146
Q	5.49	6.00	0.216	0.236
S	6.04	6.30	0.238	0.248