

Features

- 1350V Reverse Conducting Field Stop Trench Technology
- High Speed Switching
- Low Conduction Loss
- Positive Temperature Coefficient
- Easy Parallel Operation
- 175°C Operating Temperature
- RoHS Compliant
- JEDEC Qualification

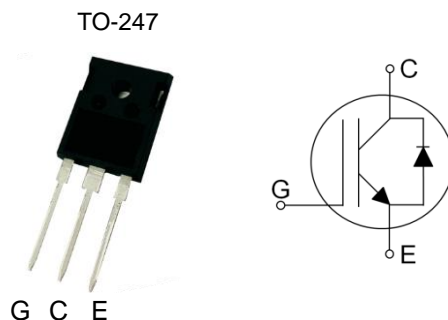

Applications

- Induction Heating
- Inverterized microwave ovens
- Soft Switching Applications

Device	Package	Marking	Remark
TGH30S135FD	TO-247	TGH30S135FD	RoHS

Absolute Maximum Ratings

Parameter	Symbol	Value	Unit
Collector-Emitter Voltage	V_{CES}	1350	V
Gate-Emitter Voltage	V_{GES}	±25	V
Continuous Collector Current	I_C	$T_C = 25\text{ }^\circ\text{C}$	60
		$T_C = 100\text{ }^\circ\text{C}$	30
Pulsed Collector Current (Note 1)	I_{CM}	180	A
Diode Continuous Forward Current	I_F	30	A
Power Dissipation	P_D	$T_C = 25\text{ }^\circ\text{C}$	366
		$T_C = 100\text{ }^\circ\text{C}$	183
Operating Junction Temperature	T_{vj}	-55 ~ 175	°C
Storage Temperature Range	T_{STG}	-55 ~ 175	°C
Maximum lead temperature for soldering purposes, 1/8" from case for 5 seconds	T_L	300	°C

Notes :

- (1) Repetitive rating : Pulse width limited by maximum junction temperature , During production, high current switching capability is 100% verified with the inductive load single-pulse switching test. ($I_C = 180\text{A}$)

Thermal Characteristics

Parameter	Symbol	Value	Unit
Maximum Thermal resistance, Junction-to-Case	$R_{\theta JC}$ (IGBT)	0.41	°C/W
Maximum Thermal resistance, Junction-to-Case	$R_{\theta JC}$ (DIODE)	0.41	°C/W
Maximum Thermal resistance, Junction-to-Ambient	$R_{\theta JA}$	40	°C/W

Electrical Characteristics $T_{vj}=25^{\circ}\text{C}$, unless otherwise noted

Parameter	Symbol	Test condition	Min.	Typ.	Max.	Unit
OFF						
Collector – Emitter Breakdown Voltage	BV_{CES}	$V_{GE} = 0V, I_C = 1mA$	1350	--	--	V
Zero Gate Voltage Collector Current	I_{CES}	$V_{CE} = 1350V, V_{GE} = 0V$	--	--	1	mA
Gate – Emitter Leakage Current	I_{GES}	$V_{CE} = 0V, V_{GE} = \pm 25V$	--	--	± 500	nA
Integrated Gate Resistor	$R_{G(int)}$	$f = 1MHz, \text{open Collector}$	--	5.3	--	Ω
ON						
Gate – Emitter Threshold Voltage	$V_{GE(TH)}$	$V_{GE} = V_{CE}, I_C = 30mA$	5.0	6.5	8.0	V
Collector – Emitter Saturation Voltage	$V_{CE(SAT)}$	$V_{GE} = 15V, I_C = 30A, T_{vj} = 25^{\circ}\text{C}$	--	1.80	2.20	V
		$V_{GE} = 15V, I_C = 30A, T_{vj} = 125^{\circ}\text{C}$	--	2.12	--	
		$V_{GE} = 15V, I_C = 30A, T_{vj} = 175^{\circ}\text{C}$	--	2.35	--	
Diode Forward Voltage	V_{FM}	$I_F = 30A, T_{vj} = 25^{\circ}\text{C}$	--	2.37	--	V
		$I_F = 30A, T_{vj} = 125^{\circ}\text{C}$	--	2.61	--	
		$I_F = 30A, T_{vj} = 175^{\circ}\text{C}$	--	2.78	--	
DYNAMIC						
Input Capacitance	C_{IES}	$V_{CE} = 30V,$ $V_{GE} = 0V$ $f = 1MHz$	--	3675	--	pF
Output Capacitance	C_{OES}		--	57	--	
Reverse Transfer Capacitance	C_{RES}		--	44	--	
Total Gate Charge	Q_g	$V_{CC} = 600V, I_C = 30A$ $V_{GE} = 15V$	--	166	249	nC
Gate-Emitter Charge	Q_{ge}		--	23	34	
Gate-Collector Charge	Q_{gc}		--	71	106	

Electrical Characteristics $T_{vj}=25^{\circ}\text{C}$, unless otherwise noted

Parameter	Symbol	Test condition	Min.	Typ.	Max.	Unit
SWITCHING (Note 2)						
Turn-Off Delay Time	$t_{d(off)}$	$V_{CC} = 600\text{V}, I_C = 15\text{A}$ $R_G = 5\Omega, V_{GE} = 15\text{V}$ Inductive Load, $T_{vj} = 25^{\circ}\text{C}$	--	113	--	ns
Fall Time	t_f		--	106	159	ns
Turn-Off Switching Loss	E_{OFF}		--	0.38	0.57	mJ
Turn-Off Delay Time	$t_{d(off)}$	$V_{CC} = 600\text{V}, I_C = 15\text{A}$ $R_G = 5\Omega, V_{GE} = 15\text{V}$ Inductive Load, $T_{vj} = 175^{\circ}\text{C}$	--	131	--	ns
Fall Time	t_f		--	213	--	ns
Turn-Off Switching Loss	E_{OFF}		--	0.70	1.05	mJ
Turn-Off Delay Time	$t_{d(off)}$	$V_{CC} = 600\text{V}, I_C = 30\text{A}$ $R_G = 5\Omega, V_{GE} = 15\text{V}$ Inductive Load, $T_{vj} = 25^{\circ}\text{C}$	--	113	--	ns
Fall Time	t_f		--	105	157	ns
Turn-Off Switching Loss	E_{OFF}		--	0.81	1.22	mJ
Turn-Off Delay Time	$t_{d(off)}$	$V_{CC} = 600\text{V}, I_C = 30\text{A}$ $R_G = 5\Omega, V_{GE} = 15\text{V}$ Inductive Load, $T_{vj} = 175^{\circ}\text{C}$	--	123	--	ns
Fall Time	t_f		--	220	--	ns
Turn-Off Switching Loss	E_{OFF}		--	1.52	2.28	mJ

Notes :

(2) Not subject to production test – verified by design/characterization

Device Characteristics

Fig. 1 IGBT Output Characteristics

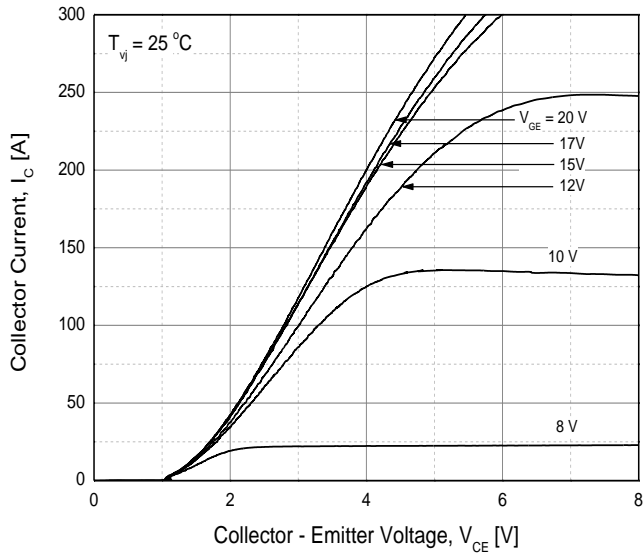

Fig. 2 IGBT Output Characteristics

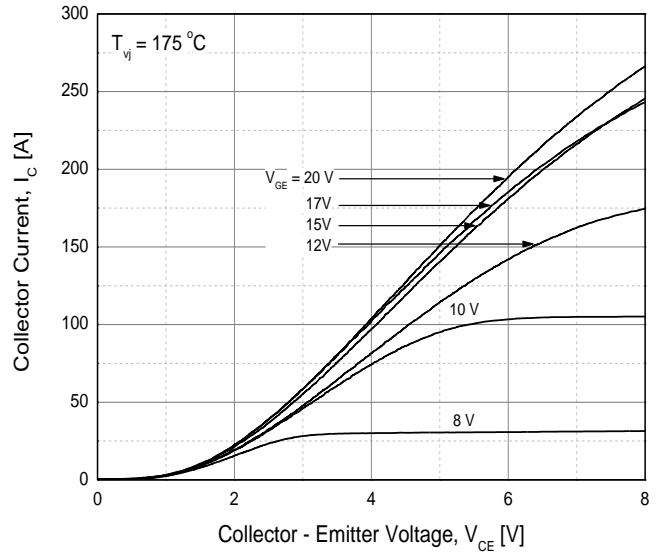
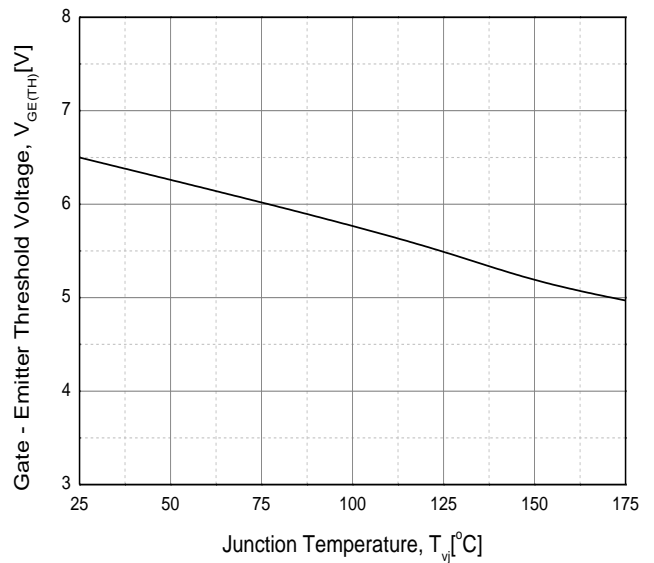
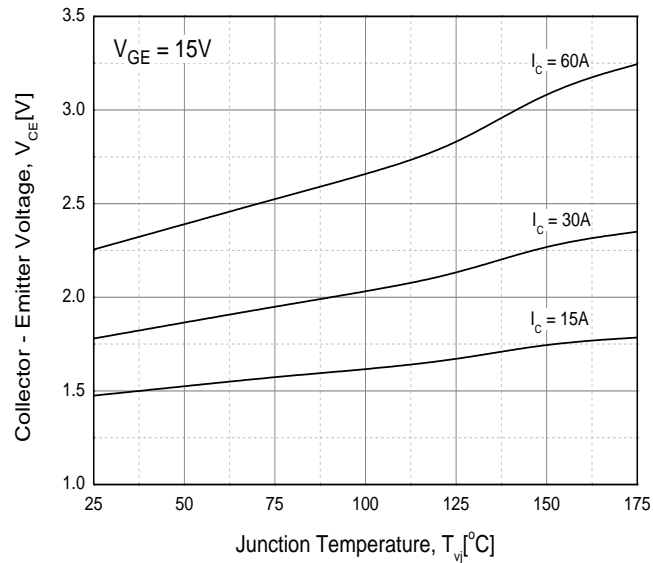

Fig. 3 IGBT Saturation Voltage vs. Junction Temperature Fig. 4 IGBT Threshold Voltage vs. Junction Temperature



Device Characteristics

Fig. 5 IGBT Transfer Characteristic

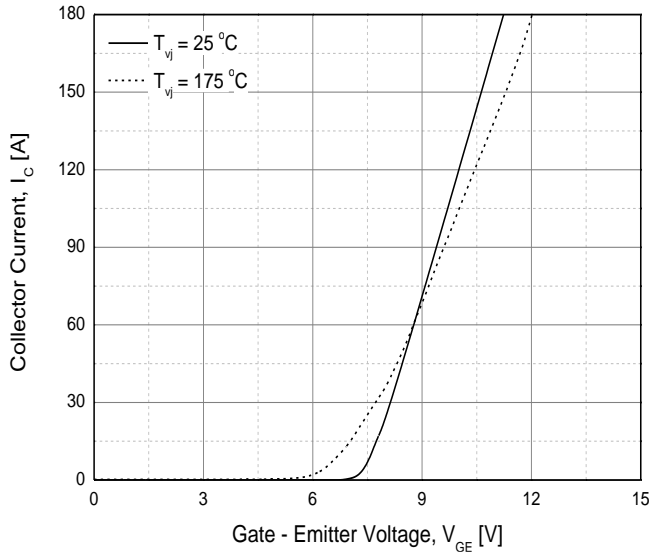

Fig. 6 IGBT Capacitance Characteristics

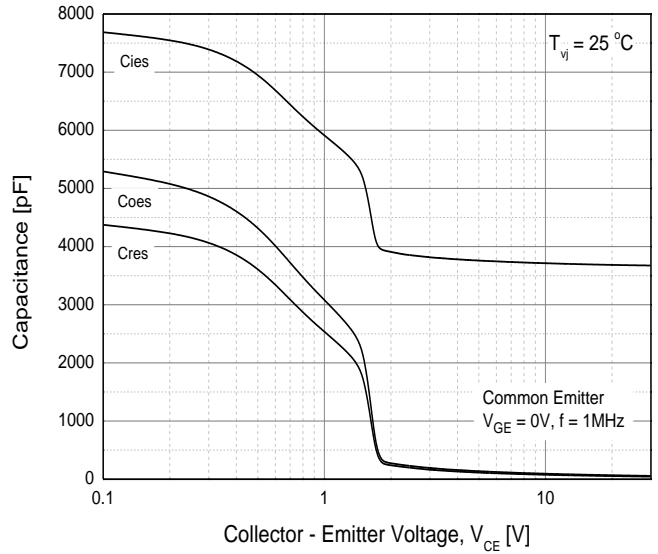

Fig. 7 Diode Conduction Characteristics

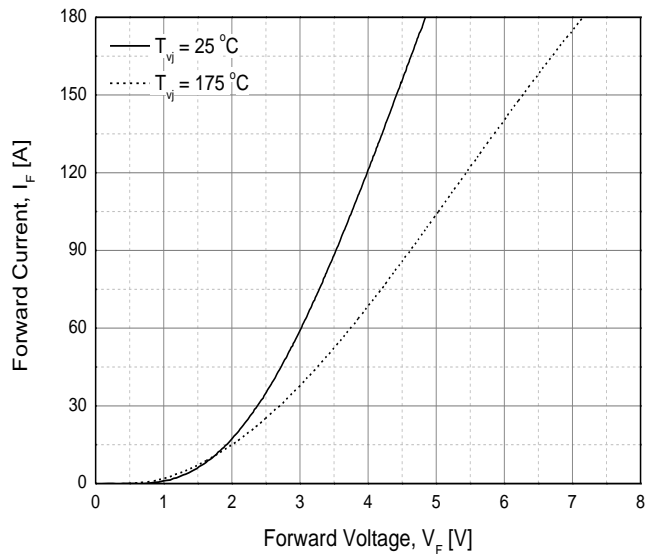
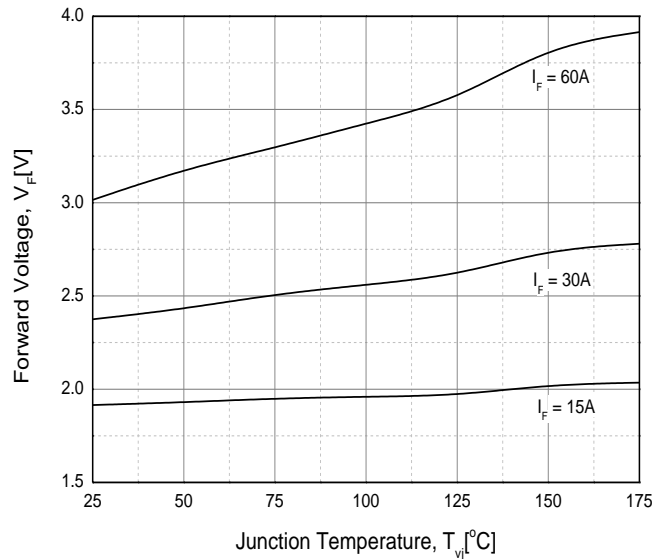

Fig. 8 Diode Forward Voltage vs. Junction Temperature



Device Characteristics

Fig. 9 Turn-off Time vs. Gate Resistor

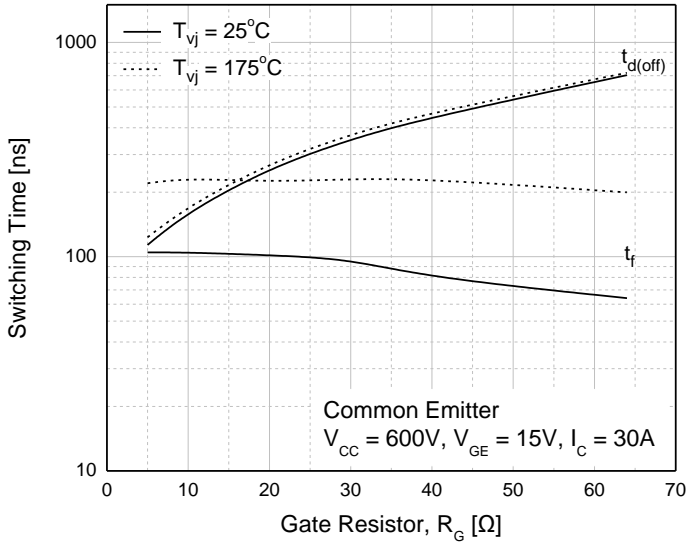

Fig. 10 Turn-off Time vs. Collector Current

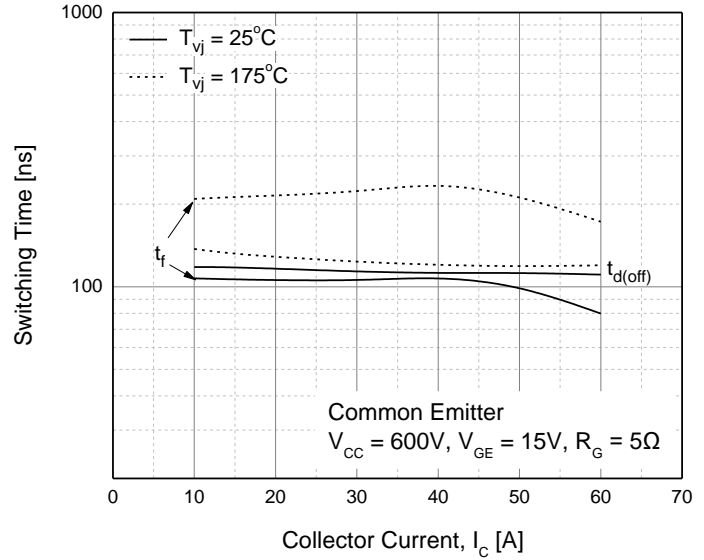

Fig. 11 Turn-off Loss vs. Gate Resistor

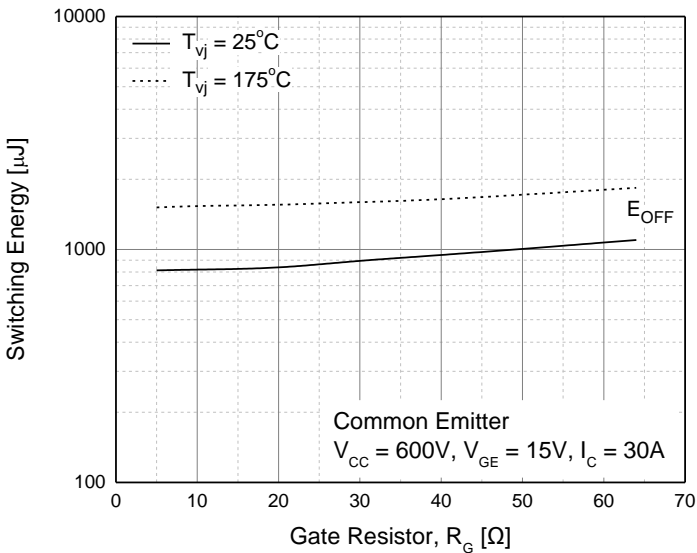
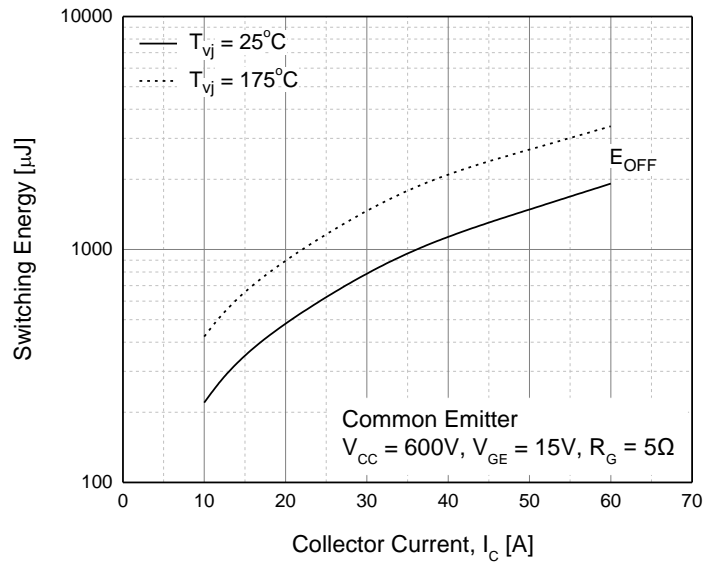

Fig. 12 Turn-off Loss vs. Collector Current



Device Characteristics

Fig. 13 Gate Charge Characteristics

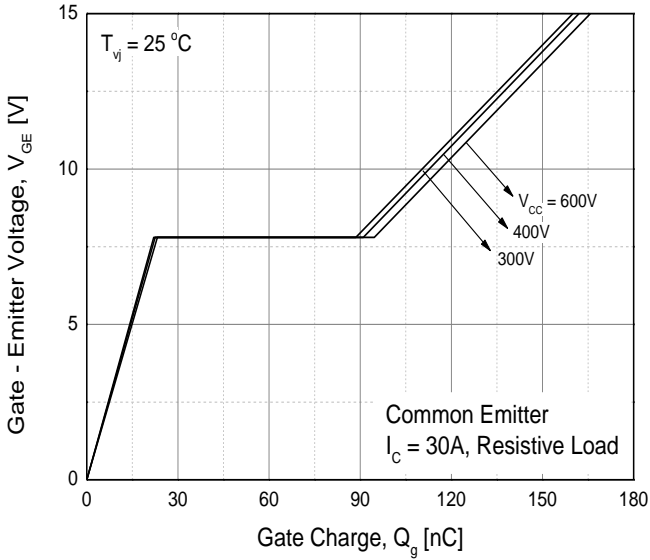

Fig. 14 Transient Thermal Impedance

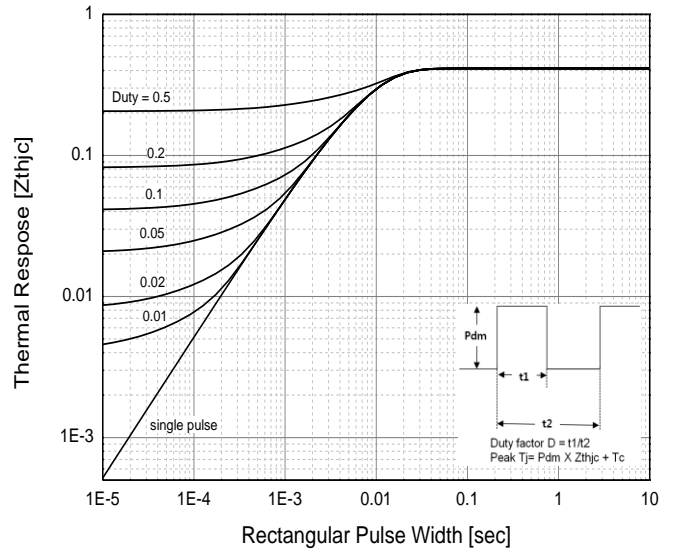

Fig. 15 Power Dissipation vs. Case Temperature

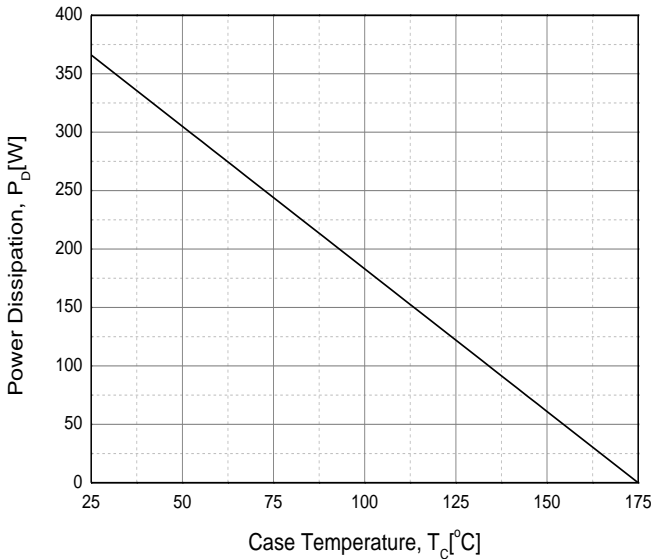
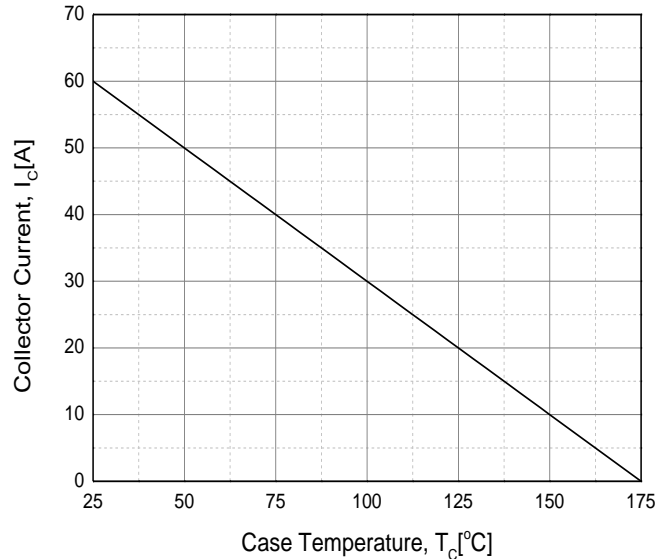

Fig. 16 Collector Current vs. Case Temperature



Device Characteristics

Fig. 17 SOA

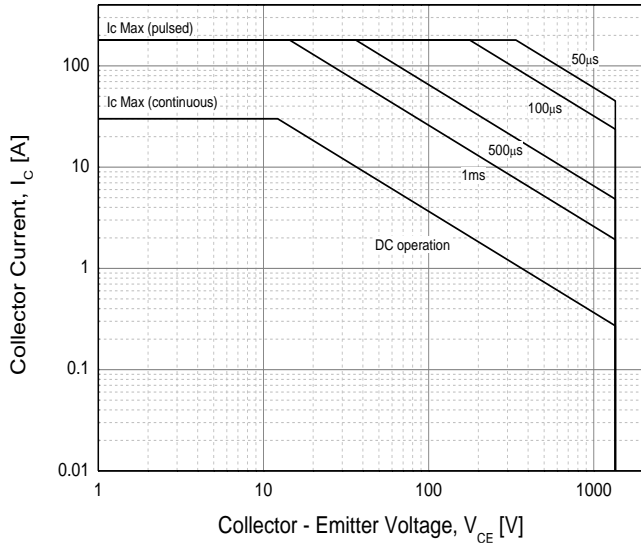

Fig. 18 RBSOA

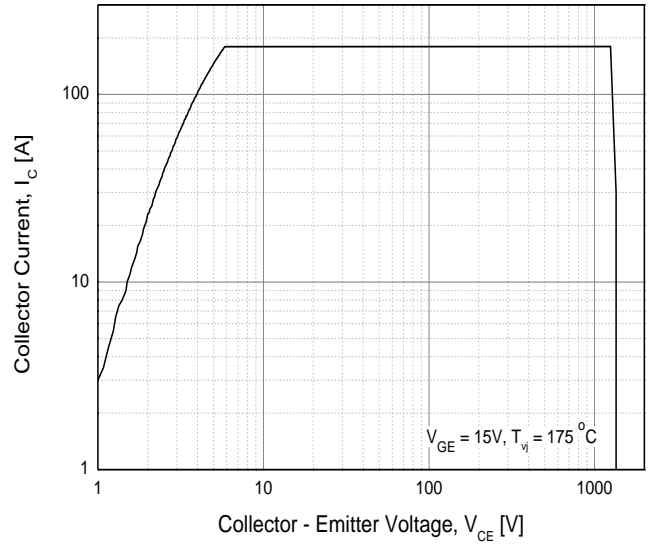

Fig. 19 Load Current vs. Frequency

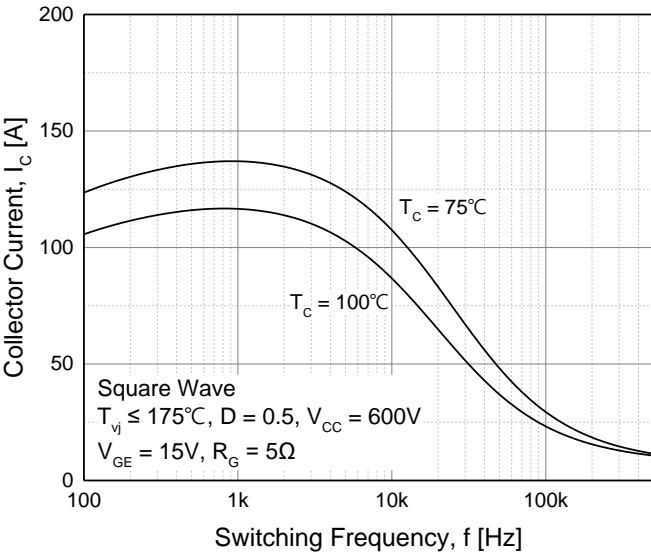
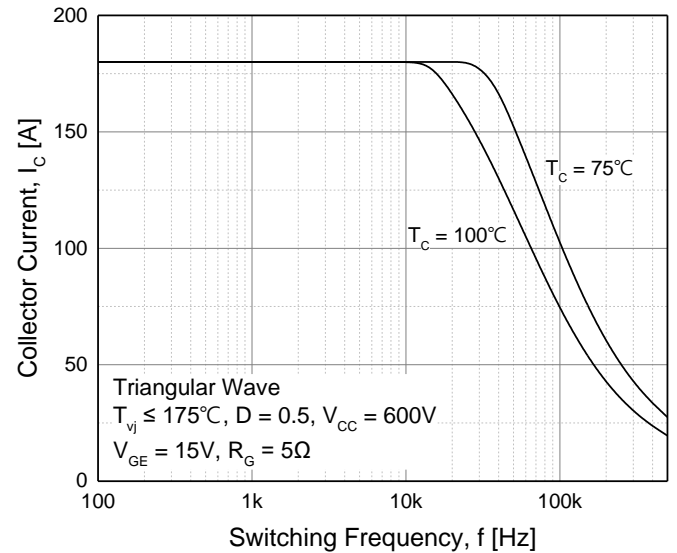
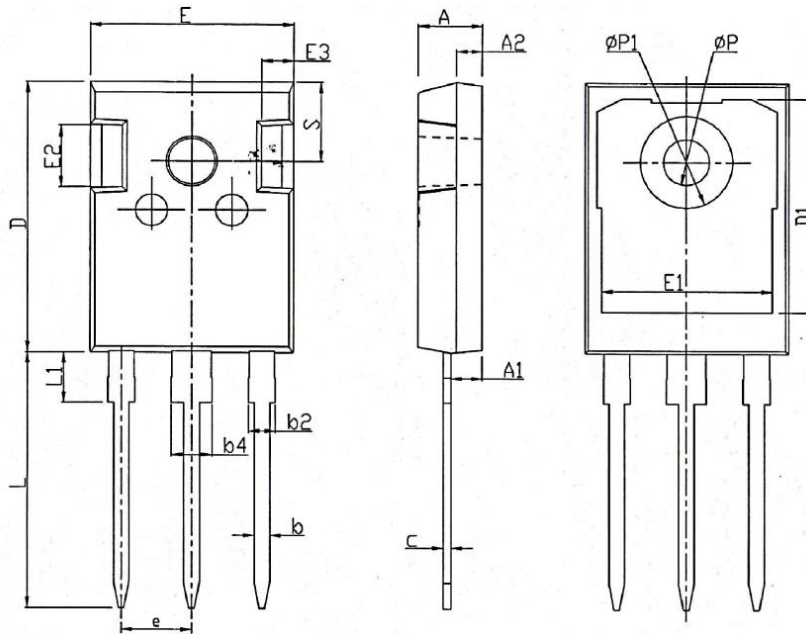

Fig. 20 Load Current vs. Frequency



TO-247 MECHANICAL DATA



SYMBOL	mm		
	MIN	NOM	MAX
A	4.80	5.00	5.20
A1	2.21	2.41	2.59
A2	1.85	2.00	2.15
b	1.11	1.21	1.36
b2	1.91	2.01	2.21
b4	2.91	3.01	3.21
c	0.51	0.61	0.75
D	20.80	21.00	21.30
D1	16.25	16.55	16.85
E	15.50	15.80	16.10
E1	13.00	13.30	13.60
E2	4.80	5.00	5.20
E3	2.30	2.50	2.70
e	5.44BSC		
L	19.62	19.92	20.22
L1	-	-	4.30
ΦP	3.40	3.60	3.80
ΦP1	-	-	7.30
S	6.15BSC		

Disclaimer

TRinno technology reserves the right to make changes without notice to products herein to improve reliability, performance, or design. The information given in this document is believed to be accurate and reliable. However, it shall in no event be regarded as a guarantee of conditions and characteristics. With respect to any information regarding the application of the device, TRinno technology hereby disclaims any and all warranties and liabilities of any kind, including without limitation, warranties of non-infringement of patent rights of any third party.